

# OTP based ration distribution system using RFID & GSM

<sup>1</sup>Avinash Babu B, <sup>2</sup>Mohan C R, <sup>3</sup>Tribhuvan S R

*Department of Electronics & Communication Engineering, Dr T Thimmaiah Institute of Technology*

**Abstract:** The Public Distribution System (PDS) is an Indian food security system that was established by the Government of India under the Ministry of Consumer Affairs, Food and Public Distribution to distribute food and non-food items to India's poor at subsidised rates. Major commodities distributed include staple food grains, such as wheat, rice, sugar and essential fuels like kerosene, through a network of fair price shops (also known as ration shops) established in several states across the country. Food Corporation of India, a government-owned corporation, procures and maintains the PDS. The major issues are the present ration distribution system are Incorrect quantity of ration distributed to consumer, Low speed of distribution, Long waiting time for the consumer, Material theft in ration shop and Corruption and malpractices in the whole system. All these happen because every job in the ration shop involves manual work and there are no specific high-tech technologies to automate the job. In order to overcome such issues, The main goal is to implementing a OTP BASED using RFID & GSM technology authentication of consumer and Automation of material distribution in ration shop. The system also help in maintaining the transaction details in a separate database in order to prevent any transgression (against of rule or law). After the card has been scanned, consumer get OTP message in register mobile number and enter the OTP to automate the distribution of commodities. At last consumer also receives the message once distributed.

**Keywords:** Public Distribution System, OTP(one time password) based , RFID(radio- frequency identification), GSM (global system for mobile communication).

## I. INTRODUCTION

As we all know that India is famous for its rich culture and diversity, India is worlds second most populated country with around 1,407,125,048 population as per the World meter elaboration in July 2022. In the country like India if want to supply food for every people means it is a big challenging thing for the government. Nearly around 664,369 villages are there in India according to the 2011 census and we have more than 5.5lakh ration shops all over the India it is one of the largest distribution networks in the world. The Planning commission of India said to the PDS system in its 2005 report that if government has spent Rs.4 on PDS means only Rs.1 is reaching to the poor people in India that means almost 57% people in the rural areas not getting the ration only.

The Public distribution system (PDS) in India was established under the Ministry of Consumer Affairs, Food, and Public Distribution. PDS supply food grains to the poor people with affordable price which operates under the joint of central and state government. under this system presently they are distributing commodities like wheat, rice, sugar and kerosene. PDS was introduced around World War II time in that time ration distribution was dependent on imports of food grains later in 1970s it was evolved into universal scheme for distribution of food grains. The classical system of Public Distribution System (PDS) was established by the Indian government to provide food security to the people. There are various ration shops in the entire nation where the people get various commodities like oil, kerosene, grains etc. At the end of every month the ration will be provided by

the ration shops which is located in the village. The customer has to go to the ration shop and ask the employee who is allocated by the public distribution system of the respective state government to provide the commodity he needs. Then the beneficiary has to provide the ration card provided by the food corporation of India (FCI). The employee then manually gives the ration to the customer. This all transaction is monitored and added into the ration card. This is the entire total interaction which take place in the ration shop between beneficiary and the employee. This system has various loop holes from beginning to till the end of the process.

## II. HISTORY OF PROJECT

The history of this project can be traced back to the Government of India's decision to digitize the public distribution system (PDS) to reduce leakages and corruption. One of the initiatives taken under this scheme was the introduction of Aadhaar-based authentication of beneficiaries. In 2016, the Government of India launched the Aadhaar-based biometric authentication system for the PDS. However, this system faced various challenges, such as network connectivity issues, biometric failures, and duplication of beneficiaries. The system was first piloted in the state of Andhra Pradesh in 2017. The pilot project was successful, and it was found that the system reduced leakages, improved transparency, and increased efficiency in the distribution of rations. by the success of the pilot project, the Government of India decided to roll out the system across the country. In 2018, the government launched the One Nation, One Ration Card scheme, which aimed to provide portability of ration cards across states and UTs using the Aadhaar-based authentication system.

## III. LITERATURE SURVEY

**A. “Automatic Ration Material Distribution Based on GSM and RFID Technology”** authors S.Valarmathy, R.Ramani, Fahim Akhtar [1] stated that Automatic Ration Materials Distribution Based uses GSM and RFID. To avail the benefit of

government userhas to scan the code using the reader to fetch the details of items allocated to the user, and then the microcontroller of system checks user's details and quantity allocated to user. The amount details are shown after authentication. Then customer need to select the necessary materials by using user interface. After receiving order, controller sends the information to authorities and customer through GSM technology.

**B. “Multi-Modality Biometric Assisted Smart Card Based Ration Distribution System”** authors Yogesh Kumar Sharma, K B Shiva Kumar [2] stated that it uses technique of fingerprint scanning as well as face detection. The database stores the records of users purchase history. They use a centralized cloud system so that transparency is maintained and users can access their details of record at some other fair price shop.

**C. “Automization of Rationing System”** authors Shivabhakt Hanamant, Suraj V. S, Moresh Mukhedkar [3] stated that it proposes atomization of distribution system at the ration shop as well as maintaining the database at one main control station and updating the database so that the shopkeeper cannot cheat the people. The tags are used for authentication of valid users. For updating, GSM is used.

**D. “Smart Ration Distribution and Controlling”** authors Kashinath Wakade, Pankaj Chidrawar, Dinesh Aitwade [4] stated that this paper uses the technique of PDA devices and the tags instead of current booklet of ration card. The device that is provided by government in this case is used as authentication card, and the e cards are used as bank creditcards to swipe and fetch the details.

**E. “Automatic Rationing System”** authors Shubham B. Parsewar, Pooja.P.Polawar Gayatree V. Paul [5] stated that Corruption has been around for a very long time and unless governments can figure out effective ways to combat it, corruption will remain in the future. The aim of this paper has

been to organize and summarize existing work on corruption, to identify opportunities for further research. The Public Distribution System (PDS) can be modernized with the help of computerization. This paper has discussed various strategies that were adapted in using ICT to control diversion and leakage in the delivery mechanism. 0.78million farmers have received computer-generated cheques without any delay as an outcome of the project. In monitoring the PDS involvement of common people has been increased.

#### F. “Automatic Ration Distributions Based on GSM and RFID Technology”

authors S.Valarmathy, R.Ramani, Fahim Akhtar [6] stated that Ration card is very important for every home nowadays. It is used for fetching the details of family members, to get a gas connection. It also acts as address proof for various purposes. To buy various materials such as sugar, rice, oil, kerosene, etc. from the ration shops, all the people have a ration card. But this system has two drawbacks, viz. Due to human mistakes weight of the material may be inaccurate, they will sell the materials to others without any intimation to the government and customers. They proposed an Automatic Ration Materials Distribution Based on GSM and RFID technology instead of ration cards in this paper in this paper. The customer needs to show the RFID tag into the RFID reader to get the materials in ration shops, then the customer code will be checked by the controller. The system will give the account details after verification.

#### G. “Smart Rationing System Using ARM 7”

authors A. N. Madur, P.N. [7] Matte stated that Corruption & leakage of goods is involved in today's public distribution. As the PDS system is manual and has many drawbacks, food article doesn't reach poor people. Actual quality food doesn't reach to people. They have replaced manual PDS with smart PDS in this paper, which can prove to be helpful to Govt. of India's PDS System and to various other disciplines. It is a vast concept in

terms of feasibility and an interesting task to perform.

#### IV. METHODOLOGY

The transformer which we are using for the purpose of the power supply is connected to the bridge rectifier it is been used to rectify the supply. The entire system is supplied with the external power supply which is turned on using the 12V DC Adapter. The system contains the main module i.e., Raspberry Pi Pico micro controller which will be the main controller of the project.

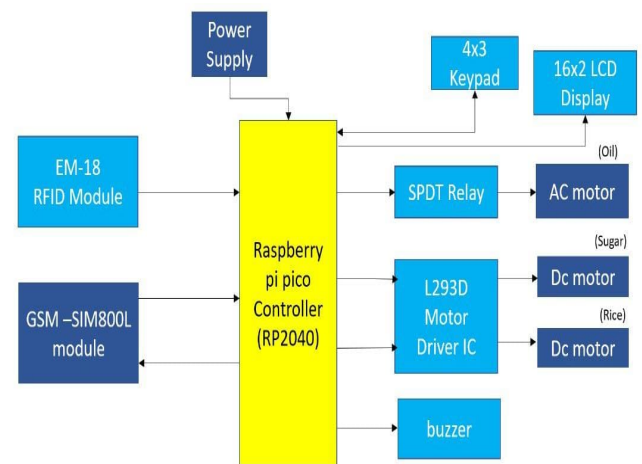

*Fig 1. Block diagram of OTP based Ration Distribution System*

The Raspberry Pi Pico board will control the entire working and also will perform the tasks based on our requirements. This Raspberry Pi Pico board will help the working of entire logic. Since the system is RFID based which is the main advantage of the system proposed. This RFID is an individual card with a unique identification number distributed to each eligible person for the ration supply. When buyer swipes the smart card to the EM-18 module will transfer information to the controller. If it is a wrong card or if the ID is not valid then the user will be notified stating it is an invalid card, else the process will move further. SIM800L is a miniature cellular module which allows for GPRS transmission, sending and receiving SMS

and making and receiving voice calls. Low cost and small footprint and quad band frequency support make this module perfect solution for any project that require long range connectivity. The OTP (One Time Password) is also verified through the keypad option. The controller will then check if it's grains or liquid and then turn on the specific driver based on the quantity entered in the Keypad. Based on the keypad details specific driver will be on and the dispenser will be opened so that specific quantity of the ration will be dispatched. The entire system will be controlled and the information will be displayed in the LCD Display that is integrated to the Raspberry.

## V. HARDWARE AND SOFTWARE REQUIREMENTS

### *Hardware Requirements*

- Raspberry Pi Pico (RP2040)
- GSM Module (SIM 800L)
- RFID Reader
- 16\*2 LCD Display
- Motor Driver (L293D)
- 4 X 3 Keypad
- SPDT Relay
- Power Supply
- Buzzer
- Ac Pump Motor

### *Software Requirements*

- Arduino Compiler 1.8.19
- Embedded C
- Flash magic software
- ISP programming

## VI. COMPONENT DESCRIPTION

### *A. Raspberry Pi Pico*

The Raspberry Pi Pico is a microcontroller board developed by the Raspberry Pi Foundation. It was released in January 2021 and is based on the RP2040 microcontroller chip, which was also developed by Raspberry Pi. The RP2040 chip features a dual-core Arm Cortex-M0+ processor, clocked at up to 133MHz, and includes 264KB of RAM, which is divided between the two cores. It also includes 2MB

of flash memory, which can be used to store programs and data. The Pico board itself includes 26 GPIO pins, which can be used to connect to a range of sensors, displays, and other components. It also includes a range of other features, including a USB port, a voltage regulator, and a programmable LED.

### *B. GSM Module (SIM 800L)*

The SIM800L is a GSM (Global System for Mobile Communications) module that is commonly used for wireless communication applications. It is a small and affordable module that can be integrated into various electronic projects. The SIM800L module supports quad-band GSM/GPRS (Global Packet Radio Service) communication, which means it can be used in almost any part of the world where there is cellular coverage. It also supports SMS (Short Message Service) and voice communication, as well as GPRS data transfer.

The module features a built-in SIM card holder and supports 3.7V Li-ion batteries. It can be controlled using AT commands through a serial interface, making it easy to interface with a microcontroller or a computer.

### *C. RFID Reader*

An RFID (Radio Frequency Identification) reader is a device that uses radio waves to communicate with and read information from RFID tags or cards. RFID technology allows for wireless identification of objects or people without direct physical contact. The RFID reader emits a radio frequency signal that activates the RFID tag or card, which then responds with its unique identification information. This information can include a unique serial number or other data that can be used to identify the object or person associated with the tag or card. RFID readers can come in various forms, from handheld devices to fixed installations. They can operate at different frequencies depending on the application, with the most common frequencies being low-frequency (LF), high-frequency (HF), and ultra-high-frequency (UHF).

#### **D. 16 X 2 LCD Display**

A 16x2 LCD (Liquid Crystal Display) display is a commonly used type of alphanumeric display that can show up to 16 characters per row and up to 2 rows of characters. The display consists of a grid of 16 columns and 2 rows of characters, each character being made up of 5x8 or 5x10 pixels. The LCD display operates by selectively blocking light from a backlight to create characters or graphics on the display. It typically includes a controller chip that communicates with a microcontroller or other device to display text and graphics on the screen. The 16x2 LCD display is widely used in electronic projects and devices that require a basic, low-power display for showing status information, data, or simple messages. It is commonly used in industrial automation, consumer electronics, and embedded systems.

#### **E. L293D motor driver IC**

The L293D is a popular motor driver IC (integrated circuit) that is used to control the speed and direction of DC motors and stepper motors. It is a dual H-bridge driver, which means it can control the direction of two DC motors or one stepper motor. The L293D motor driver IC can handle a maximum continuous current of up to 600mA per channel and a peak current of up to 1.2A per channel. It also includes built-in protection features such as thermal shutdown and overcurrent protection. The motor driver IC can be controlled using digital inputs from a microcontroller or other device, with each input corresponding to a specific motor control function such as forward, reverse, or brake.

#### **F. 4 X 3 Keypad**

A 4x3 keypad is a type of input device that consists of 12 keys arranged in a 4x3 matrix. Each key corresponds to a unique combination of row and column, allowing for up to 12 different input values. The 4x3 keypad is commonly used in electronic projects and devices that require a simple, low-cost input method for entering data or commands. It is often used in security systems, access control systems, and other applications where a basic PIN code entry or menu selection is required.

#### **G. SPDT Relay**

A SPDT (Single Pole Double Throw) relay is an electromechanical device that allows an electrical circuit to be switched on and off using a low-power signal or control voltage. It consists of a coil, a set of contacts, and a mechanical mechanism that moves the contacts when the coil is energized. The SPDT relay has three terminals: a common (COM) terminal, a normally open (NO) terminal, and a normally closed (NC) terminal. When the coil is not energized, the common terminal is connected to the NC terminal, completing the circuit. When the coil is energized, the common terminal is switched to the NO terminal, breaking the circuit.

#### **H. Power Supply**

A power supply is 5v and the electronic device that converts electrical power from a source, such as an AC wall outlet or battery, into the type of power needed by electronic devices. Power supplies can provide various types of power, including AC, DC, and regulated or unregulated power.

#### **I. AC pump motor**

An AC pump motor is an electric motor that is designed to power a pump in an AC (alternating current) electrical system. AC pump motors can be found in a variety of applications, including water pumps, air conditioning systems, refrigeration systems, and hydraulic systems.

#### **J. Embedded C**

Embedded C is one of the most popular and most commonly used Programming Languages in the development of Embedded Systems. Embedded C is perhaps the most popular languages among Embedded Programmers for programming Embedded Systems. There are many popular programming languages like Assembly, BASIC, C++ etc. that are often used for developing Embedded Systems but Embedded C remains popular due to its efficiency, less development time and portability.

### K. Arduino IDE

Arduino is a prototype platform (open-source) based on an easy-to-use hardware and software. It consists of a circuit board, which can be programmed (referred to as a microcontroller) and a ready-made software called Arduino IDE (Integrated Development Environment), which is used to write and upload the computer code to the physical board. Arduino provides a standard form factor that breaks the functions of the micro-controller into a more accessible package.

### L. Flash Magic Software

Flash Magic is a software tool for programming flash-based microcontrollers from NXP Semiconductors (formerly Philips Semiconductors). It is used to program a range of microcontrollers, including those based on the ARM Cortex-M0, Cortex-M3, and Cortex-M4 architectures. Flash Magic allows users to program microcontrollers in-circuit using a serial or USB connection. The software provides a user-friendly interface for programming and verifying the flash memory of the microcontroller, as well as erasing the memory and performing other maintenance functions.

### M. ISP Programming

ISP (In-System Programming) programming is a method of programming microcontrollers that allows the device to be programmed while it is still installed on a printed circuit board (PCB). This programming method uses a special programming interface that connects to the microcontroller through its pins or pads. The advantage of ISP programming is that it eliminates the need to remove the microcontroller from the circuit board, which can save time and reduce the risk of damage to the device or the PCB. This is particularly useful in mass production or repair scenarios, where a large number of devices need to be programmed or updated quickly and efficiently. ISP programming typically uses a programming interface or protocol that allows the microcontroller to be connected to a programming tool, such as a programmer or debugger. The interface or protocol may use a variety of communication methods, such as

SPI, I2C, UART, or USB. ISP programming is commonly used in embedded systems development, as it allows for faster and more efficient programming of microcontrollers.

## VII. IMPLEMENTATION

### A. Flow Chart for Arduino UNO

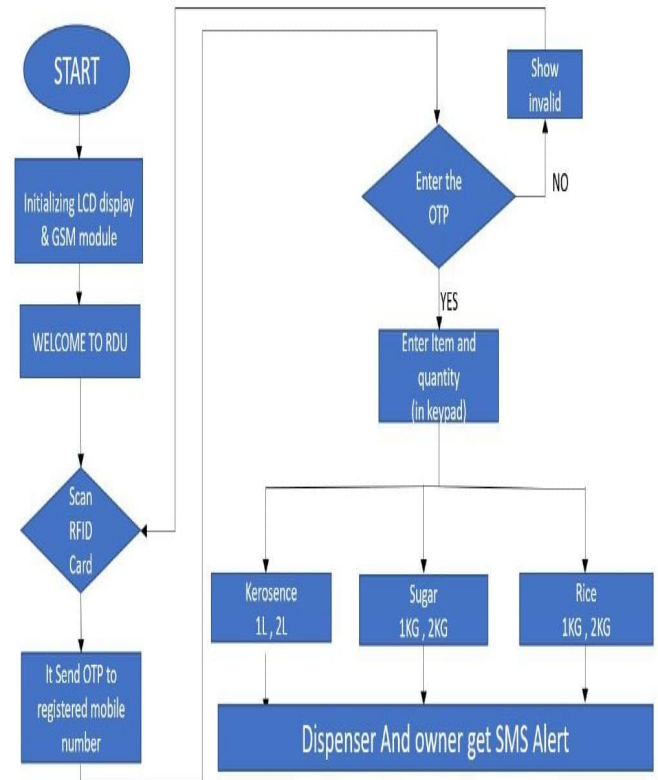

**Fig 2 (a). Flow chart for OTP Based Ration distribution System**

#### Steps

1. Every consumer is provided with a RFID card who are registered in the Food corporations of India through PDS.
2. When consumer goes to the Fair Price shop (FPS), he/she has to carry the smart card and mobile phone.
3. Now the customer has to scan the RFID card or Tag in EM-18 RFID Module .
4. If the RFID card is valid it displays the consumer name in LCD display. If the card is

valid means it display “INVALID CARD”.

5. The above step is correct means registered mobile number receives an OTP which can be used as password. The registration is the system generates a unique OTP for each ration cardholder. This OTP is sent to the registered mobile number of the beneficiary.

6. Now the customer has to enter the 4 digit OTP received the mobile through keypad. he beneficiary needs to provide the OTP received on their mobile number to authenticate themselves at the time of collecting rations. This authentication can be done through Keypad.

7. After entering OTP , its show Name of item and quantity and select Based on type of material chosen by the consumer, the motor or solenoid valve is activated.

8. After collecting proper quantity material, motor or solenoid is disabled.

9. Once the beneficiary is authenticated, the ration is distributed to them. The system records the transaction and updates the inventory of the ration shop. inventory update: The system updates the inventory of the ration shop to reflect the distribution of the rations. Transaction record: The system records the transaction for future reference and transparency. End of transaction: The beneficiary collects their rations, and the transaction is complete.

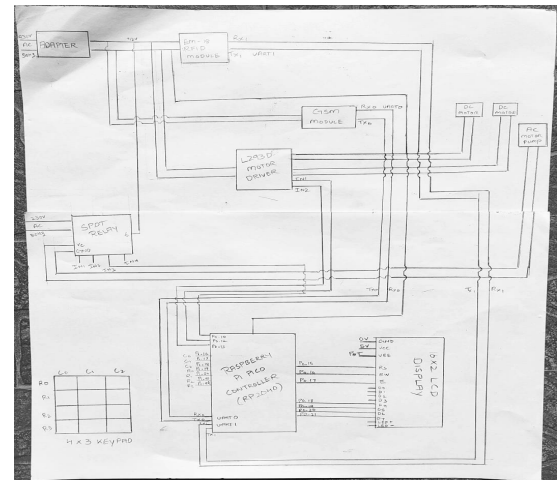

**Fig 2 (b). Circuit Connection for OTP Based Ration distribution System**

### VIII. RESULT

Ration Dispensing automation is a growing trend that shows no sign of slowing down. Continued automation technology will drive system/organizations to an ever-greater level of efficiency and performance. In order to stay competitive in your particular market, we have to upgrade the system and educate the people. the OTP-based ration distribution system using RFID and GSM has the potential to improve the efficiency, transparency, and security of ration distribution programs. However, it is important to carefully consider the costs and technical requirements before implementing this type of system.

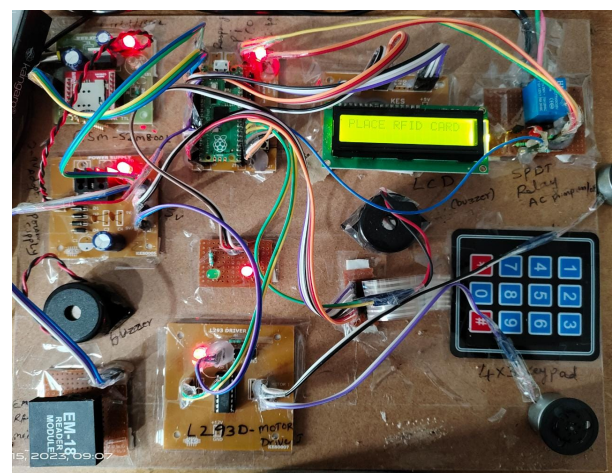

**Fig 3. smart distribution system setup**

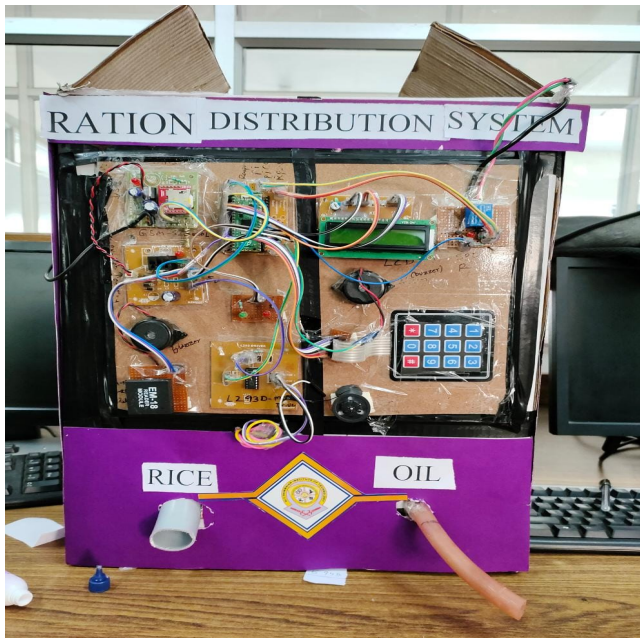

**Fig 4. Outlook of the Project**

When the power supply is given to the model the first message to be displayed is shown in the figure above.

**Fig 5. sending OTP**

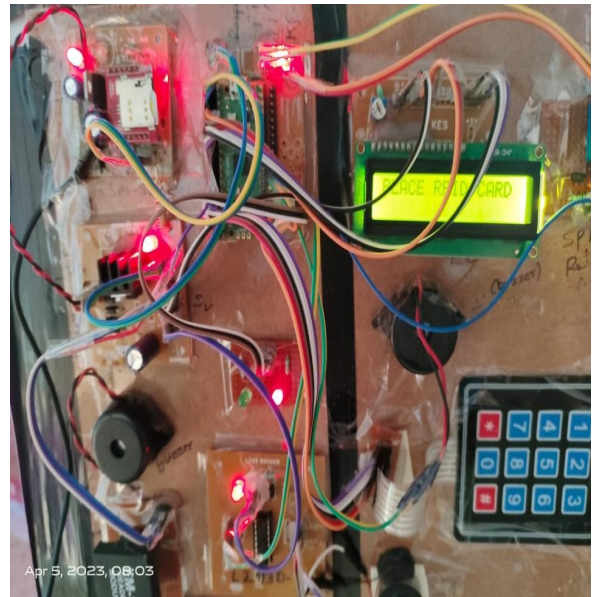

**Fig 6. scan RFID card**

**Fig 7. Enrolled Number Get an OTP**

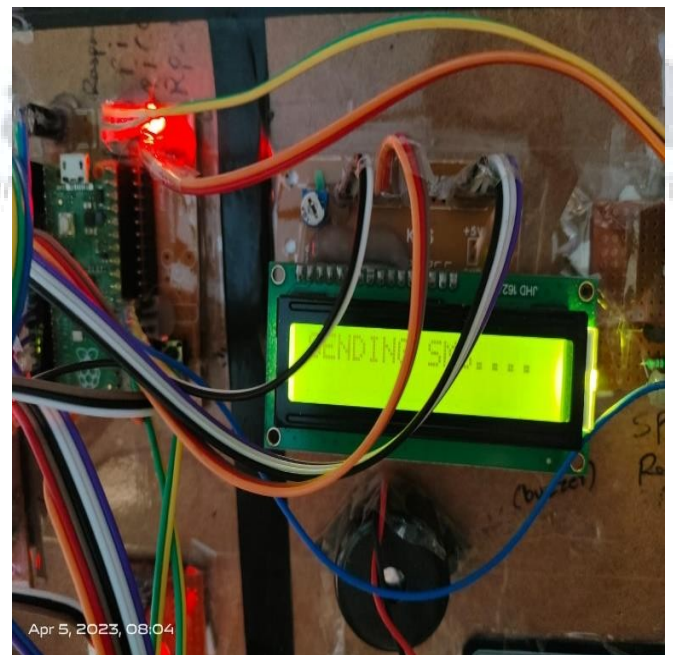

The Smart ration distribution system has been implemented and working was shown in fig 4 which consists of RP2040, 16x2 LCD display, 4x3 keypad, SPDT Relay, GSM module, RFID reader, L293 Motor driver.



Now customers receive an OTP which can be used as password for further process it is show in the above fig. If the entered password is wrong “Displays Password Invalid”.

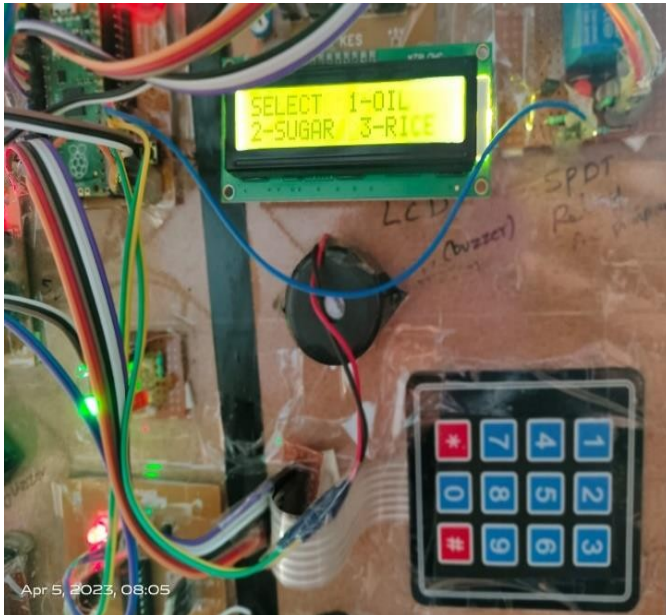

**Fig. 8 Select the Item**

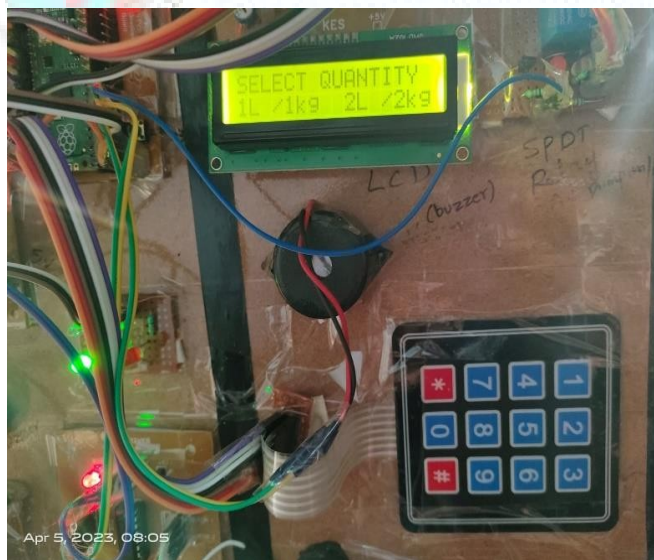

**Fig. 9 Select the quantity**

Fig 9. Shows we have to select the quantity of ration through input 4x4 keypad here (button 1 and 2 for liquid Item) and (button 3 and 4 for grains).

## IX. CONCLUSION AND FUTURESCOPE

### Conclusion

The current classical method has two flaws. Firstly, human error might lead to an incorrect estimate of the goods weight. Secondly, without notifying the customers, the commodities may be sold to others if they are not purchased at the ration shop during the month. The suggested solution can be used to resolve the above limitations. Due to its high accuracy, this device is suitable for actual-time applications. Under the digital India, we may further improve the use of face recognition and biometric identification. Hence, on the basis of a review of literature survey and by looking at the current system. We have determined that the recommended device will help to automate the system. Initially implementation of this project takes time once if it is implemented all the people who are eligible for these facilities will get food supply under the Act of right to equality and Consumer rights and we can able to educate them the new technologies so that they will be updated in future to use the upcoming automated system.

### Future Scope

In future, high-quality sensors and hardware can be used for efficient implementation. This Automatic rationing system can be converted in different regional languages. In future, Payment can be done online by connecting customers bank account directly to the PDS account due to this human interference in transaction process will be reduced completely. GPS tracking of the PDS delivery trucks can also be done. Online quotation can be opened for farmers, connecting them directly with the government authorities. Apart from being limited to this specific domain, the application of this particular improvement in the current working of the ration shop has a lot of scope in various other areas. This system can be re sized up to handle a large number of items which can be chosen from a single controller.

## REFERENCES

- [1] S.Valarmathy1, R.Ramani1, Fahim Akhtar2, S.Selvaraju2, G.Ramachandran2, **Web-Enabled Ration Distribution and Controlling** In MECS, Published Online October 2013.
- [2] Yogesh Kumar Sharma, K. B. Shiva Kumar, **"Multi-Modality Biometric Assisted Smart Card Based Ration Distribution System"** International Journal of Application or Innovation in Engineering & Management, 2014, Vol.3, Issue 6, pp. 382-392.
- [3] Shivabhakt Mhalasakant Hanamant, Suraj V. S., Moresh Mukhedkar, **"AUTOMIZATION OF RATIONING SYSTEM"**, Published in IJCEM International Journal of Computational Engineering & Management, Vol. 17 .
- [4] kashinath Wakade, Pankaj Children, Dosh Altwade **SMART RATION DISTRIBUTION AND CONTROLLING** Published In International Journal of Scientific and Research Publications Volume 5 bout 4 April 2015 1 ISSN 2250-3153
- [5] Shubham B. Parsewar, Pooja P.Polawar, Gayatree V. Paul, **"Automatic Rationing System"**, International Journal of Innovations in Engineering and Technology (IJJET) Volume 6 Issue 2 December 2015.
- [6] S.Valarmathy1, R.Ramani1, Fahim Akhtar2, S.Selvaraju2, G.Ramachandran2, In MECS, Published Online October 2013.
- [7] A.N.Madur, Sham Nayse, **"Automation in Rationing System Using Arm 7,"** International journal of innovative research in electrical, electronics, instrumentation and control engineering ,vol.1, Issue 4, Jul 2013.
- [8] K.Balakarhik, **"Closed-Based Ration Card System using RFID and GSM Technology,"** vol.2, Issue 4, Apr 2013.
- [9] Rajesh C. Pingle And P. B. Boroley, **Automatic Rationing For Public Distribution System (Pds) Using Rfid And Gsm Module To Prevent Irregularities**, HCTL Open IJTIR, Volume 2, March 2013.
- [10] S.Sukhumar1, K.Gopinathan2, S.Kalpanadevi3, P.Naveenkumar4, N.Suthanthira Vanitha5, **Automatic Rationing System Using Embedded System Technology**, International Journal Of Innovative Research In Electrical, Electronics, Instrumentation And Control Engineering Vol. 1, Issue 8, November 2013.
- [11] A.A. Mulla1, Z. A. Mulla2, **Microcontroller Based Weighing Machine**, IJCES, ISSN:22316590, Nov. 2013.
- [12] Munyao Kitavi, **Design And Fabrication Of A Microcontroller Based Electronic Weighing Machine In High Mass Regime**, Reg. No:156/7254/02.
- [13] Dhanoj Mohan[1], Rathikarani[2], Gopakumar, **Automation of Ration Shop Using Plc**, IJMER, ISSN: 2249-6645, Vol. 3, Issue. 5, Sep - Oct.2013 pp-2971-2977.
- [14] Rajesh C. Pingle and P. B. Boroley, **"Automatic Rationing for Public Distribution System (PDS) using RFID and GSM Module to Prevent Irregularities"** HCTL Open International Journal of Technology Innovations and Research, 2013, Vol. 2, pp. 102-111.